

# P 2110T

## WEATHERPROOF COAXIAL TWO WAY SPEAKER

### DESCRIPTION

The P2110-T is a weatherproof full range, wide-dispersion, coaxial two way loudspeaker system offering substantial power and efficiency for a variety of professional indoor or outdoor applications. The high-frequency section is a constant directivity CMD horn loaded to a 1" RCF Precision compression driver with a 1.50" diaphragm assembly for smooth, wide dispersion. The low-frequency transducer is a 10" woofer with a 2.5" voice coil. The cabinet is a single piece rotational moulded in medium density polyethylene, fully UV protected.

The cabinet is equipped with 12 x M 8 brass inserts, a stainless steel U-Bracket and pair of spacers for 90° mounting. The front logo is in aluminium and rotatable. The grille is in custom perforated aluminium with open-cell fibres and water repellent woven fabric backing. The system features a selectable line transformer for 70 - 100 Volt applications. P 2110-T is suitable for indoor and outdoor applications/installations, it meets the requirements of IP 55 code (International Protection Rating).



### FEATURES

- Cabinet is a single piece rotational moulded in medium density polyethylene, fully UV protected and waterproof IP 55
- Front grille in custom perforated aluminium with open-cell fibres and water repellent woven fabric backing
- Stainless steel bracket
- One 10" high-output LF transducer with 2" voice coil
- One RCF Precision 1" Compression Driver with 1.5" voice coil
- 90° x 40° constant directivity horn
- Built in passive crossover and selectable line transformer
- 10° X 20° enclosure sides for array configurations
- Active Mosfet Compression Driver Protection
- LICC (Low Impedance Compensated Crossover) network

## TECHNICAL SPECIFICATIONS

<b>Acoustical specifications</b>	Frequency Response (-10dB):	95 Hz ÷ 20000 Hz
	Max SPL @ 1m:	124 dB
	Horizontal coverage angle:	90°
	Vertical coverage angle:	40°
	Directivity index Q:	11
	System Sensitivity:	95 dB
<b>Power section</b>	Nominal Impedance (ohm):	16 ohm
	Power Handling:	200 W RMS
	Peak Power Handling:	800 W PEAK
	Recommended Amplifier:	400 W
	Protections:	Dynamic active mosfet
	Crossover Frequencies:	2000 Hz
<b>Transducers</b>	Compression Driver:	1.0", 1.5" v.c
	Nominal Impedance (ohm):	8 ohm
	Input Power Rating:	25 W AES, 50 W PEAK
	Sensitivity:	106 dB, 1W @ 1m
	Woofer:	Coaxial 10", 2.5" v.c
	Nominal Impedance (ohm):	16 ohm
	Input Power Rating:	180 W AES, 360 W PEAK
Sensitivity:	95 dB, 1W @ 1m	
<b>Input/Output section</b>	Input connectors:	Neoprene Cable
	Constant Voltage Transformer:	100 V
	Power selection 1 (100 V):	60 W - 167 ohm
	Power selection 2 (100 V):	30 W - 333 ohm
	Power selection 3 (100 V):	15 W - 667 ohm
<b>Standard compliance</b>	IP protection grade:	IP 55
	CE marking:	Yes
<b>Physical specifications</b>	Cabinet/Case Material:	PE Low Density
	Hardware:	12 x M8 inserts + U-brackets and pair of spacers
	Grille:	Aluminum with waterproof clothing
	Color:	Grey
<b>Size</b>	Height:	350 mm / 13.78 inches
	Width:	350 mm / 13.78 inches
	Depth:	320 mm / 12.6 inches
	Weight:	13.4 kg / 29.54 lbs
<b>Shipping informations</b>	Package Height:	400 mm / 15.75 inches
	Package Width:	370 mm / 14.57 inches
	Package Depth:	370 mm / 14.57 inches
	Package Weight:	16.3 kg / 35.94 lbs



**PART NUMBER**

- **13000125**

P 2110T

EAN 8024530008246

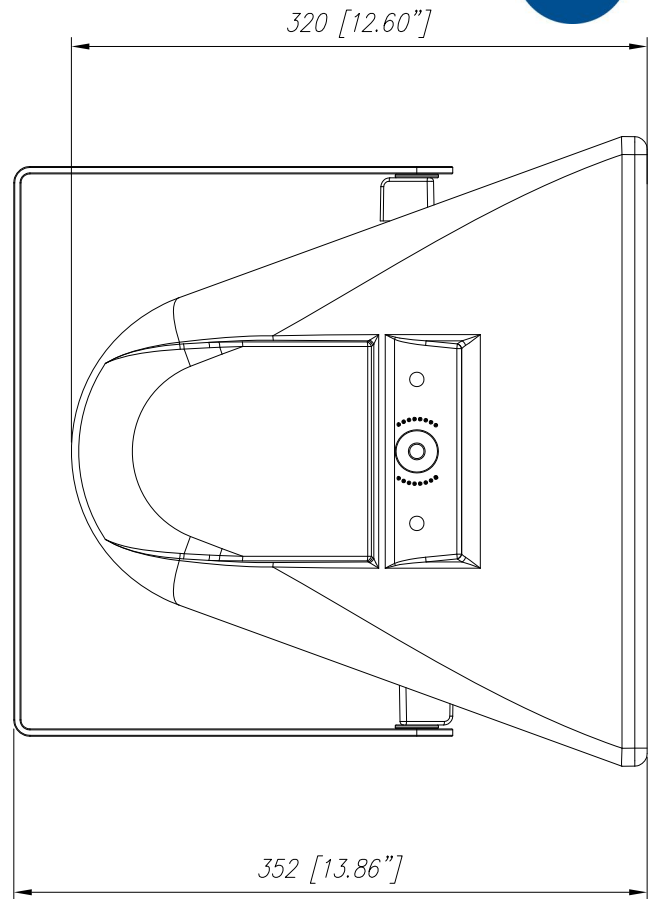
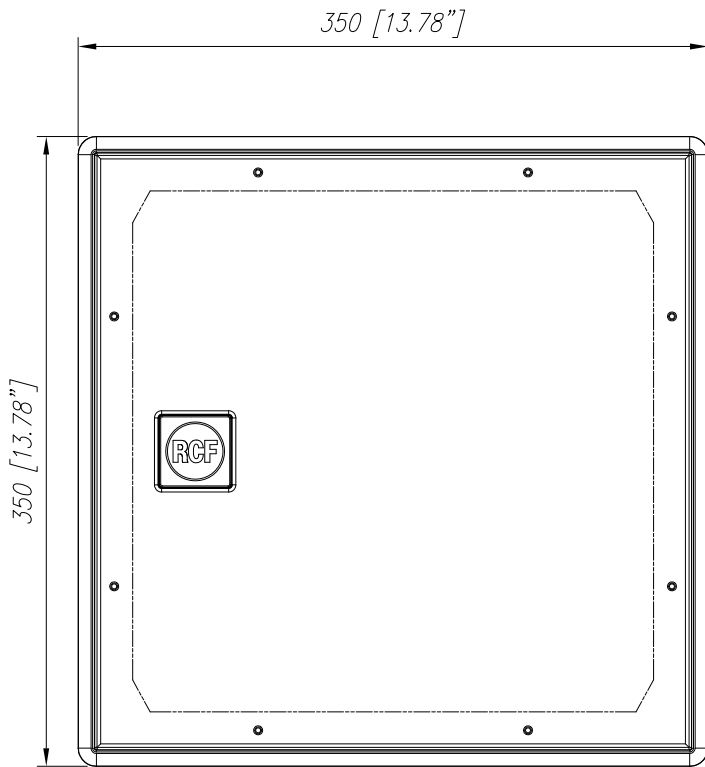

P2110

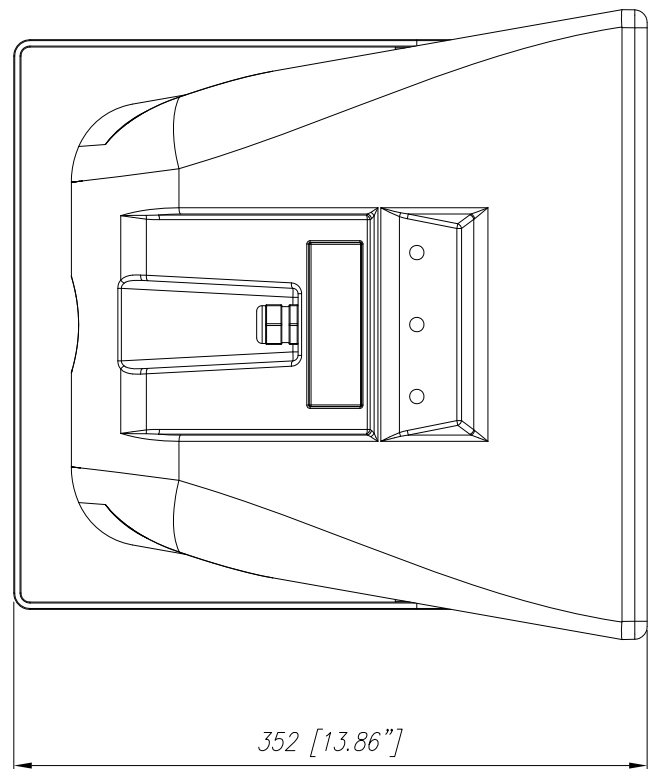

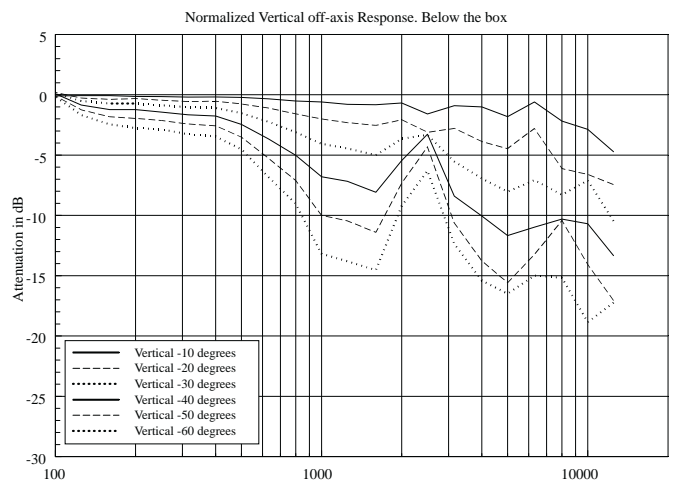
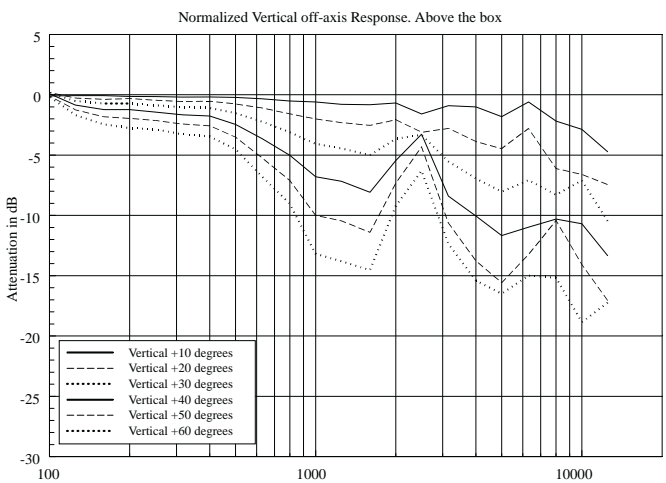
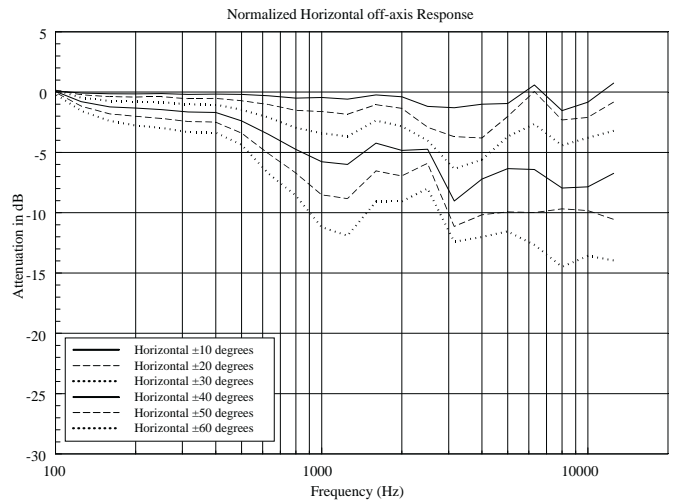
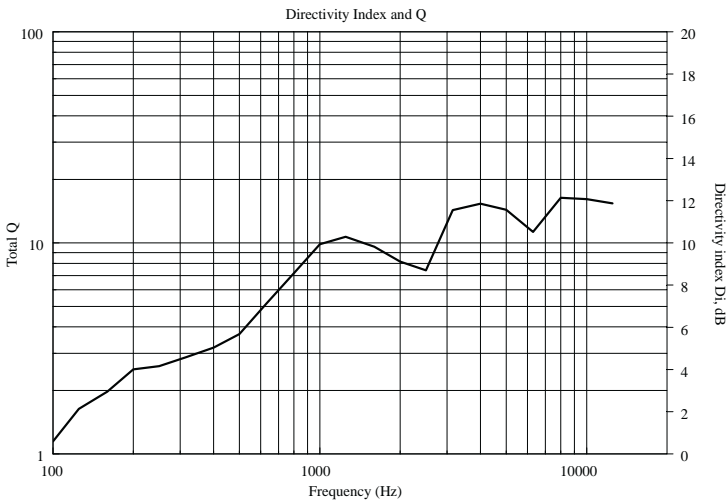
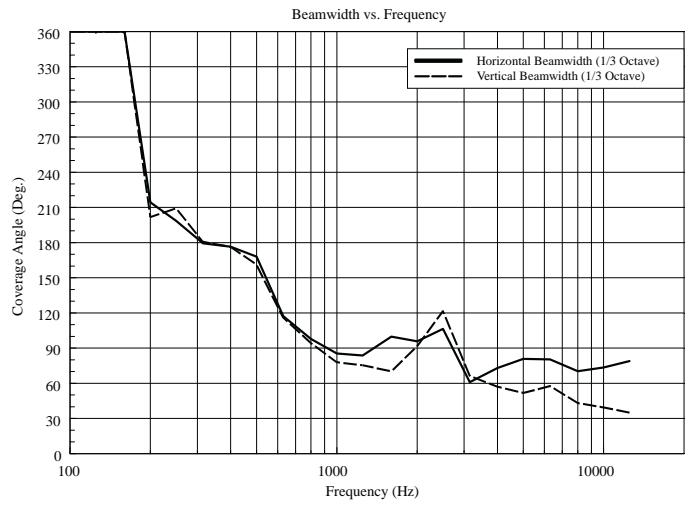
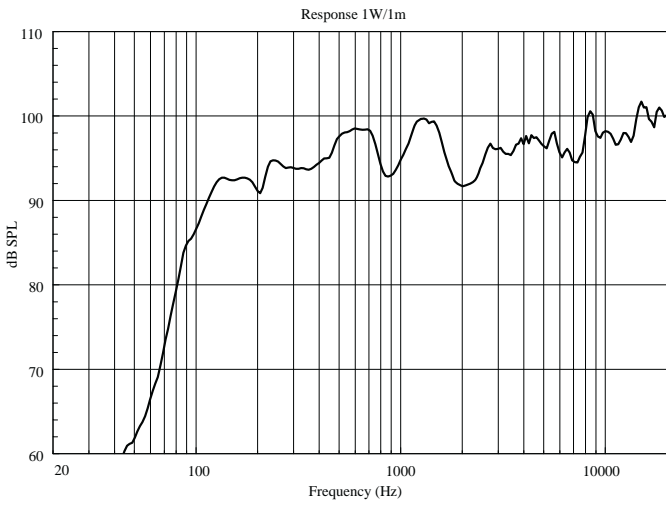

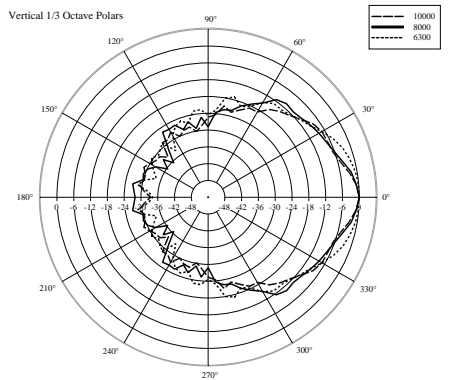
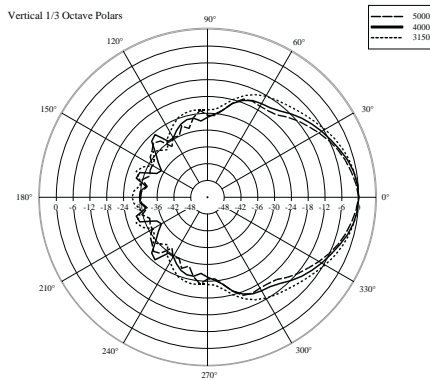
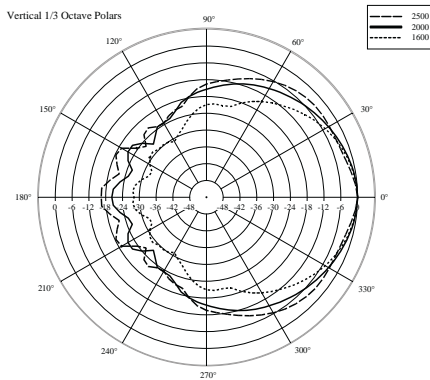
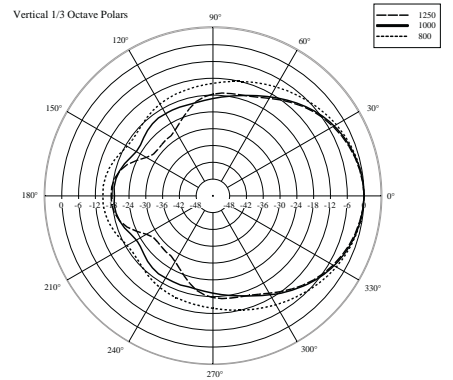
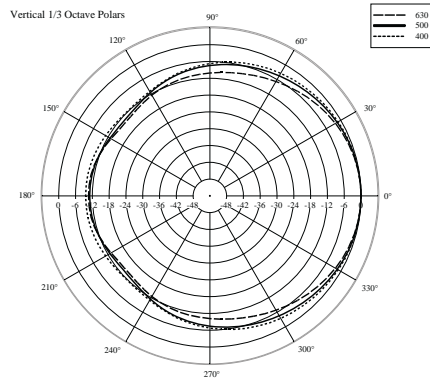
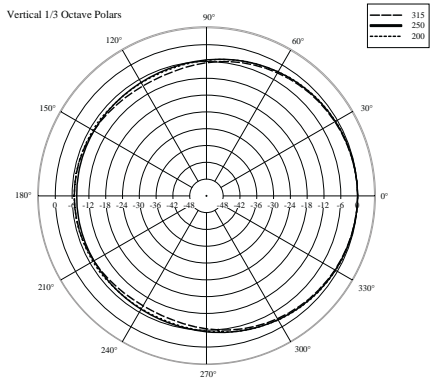
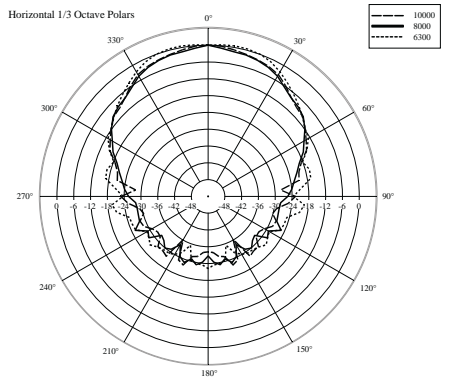
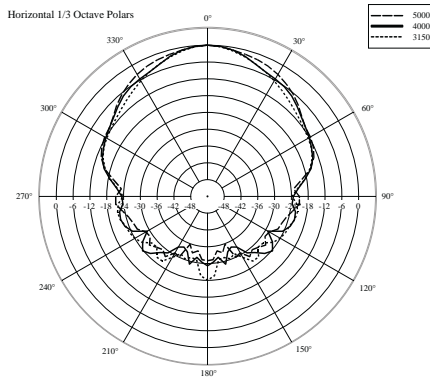
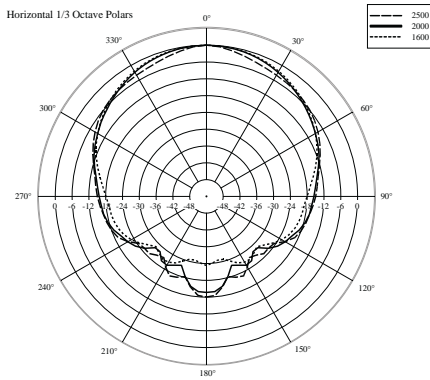
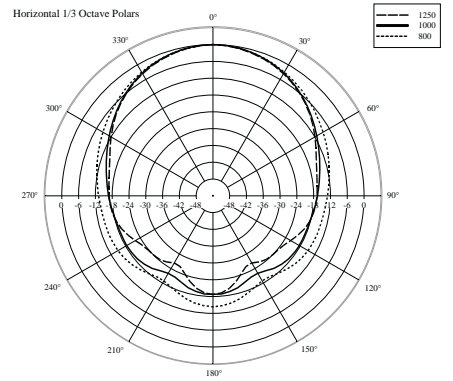
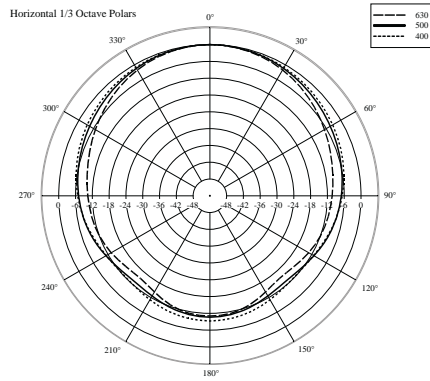
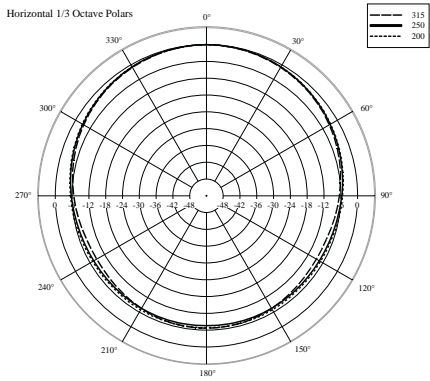



**ACCESSORIES**